

Mounting and Service Instructions

Room controller



Logamatic EMS

RC35 user interface

For trained and certified installers

Read carefully prior to installation and maintenance.

6 720 640 227 - 05/2009 US/CA

Buderus

Contents

1	Explanation of symbols and safety instructions	4
1.1	Explanation of symbols	4
1.2	Safety instructions	6
2	Product description	7
2.1	Correct use	7
2.2	Certifications	7
2.3	Package contents	7
2.4	Technical specifications	8
2.5	Applicability of these instructions for function modules (accessories)	9
2.6	Accessories	9
3	Installation	10
3.1	Choosing the right installation location	10
3.1.1	Installation in reference room	10
3.1.2	Installation on boiler	11
3.2	Types of installation	11
3.3	Installation and connection	12
3.4	User interface: attaching or removing	13
4	Operating basics	14
4.1	Overview of operation	14
4.2	Introduction to the Service menu	15
4.3	Overview of the Service menu	17
5	Commissioning	18
5.1	General commissioning	18
5.2	Checklist: important parameters for commissioning	19
5.3	Quick commissioning (Quick operation menu)	20
5.4	Detailed commissioning	21
5.5	System commissioning	21
5.6	Shut-down/switching off	22
5.7	Operating tips	23

6	Entering system settings (Service menu – Settings)	24
6.1	System data	24
6.1.1	Type of building (“damping” of outdoor temperature)	25
6.1.2	Minimum outdoor temperature	26
6.2	Boiler data	27
6.3	Heating zone data	28
6.3.1	Assignment of user interface/remote control unit in the software	32
6.3.2	Control mode (outdoor temperature controlled/room influence)	32
6.3.3	Characteristic heating curve	33
6.3.4	Reduction modes (night setback)	34
6.3.5	Frost protection	35
6.4	Domestic hot water (DHW)	37
6.5	Solar data	39
6.6	RC35 calibration	40
6.7	Contact data	41
<hr/>		
7	Diagnosis	42
7.1	Function test	42
7.2	Monitor value	43
7.3	Error message	44
7.4	Characteristic heating curve	45
7.5	Versions	45
<hr/>		
8	Service	46
<hr/>		
9	Reset	47
<hr/>		
10	Troubleshooting	48
<hr/>		
11	Service menu RC35	54
<hr/>		
	Index	55
<hr/>		
	Notes	57

1 Explanation of symbols and safety instructions

1.1 Explanation of symbols

Warnings



Warnings in the text are indicated by a warning triangle with a gray background in a framed box.



In case of danger due to current, the exclamation point on the warning triangle is replaced with a lightning symbol.

Signal words at the beginning of a warning are used to indicate the type and seriousness of the ensuing risk if measures for minimizing damage are not taken.

- **NOTE** indicates that damage to property may occur.
- **CAUTION** indicates possible minor to medium personal injury.
- **WARNING** indicates possible severe personal injury.
- **DANGER** indicates that severe personal injury may occur.

Important Information



Important information that presents no risk to people or property is indicated with this symbol. They are separated by lines above and below the text.

Additional symbols

Symbol	Explanation
▶	Sequence of steps
→	Cross-reference to other points in this document or to other documents
•	Listing/list entry
–	Listing/list entry (2nd level)

Tab. 1

Display text: Words appearing on the display are shown in **bold** in the text.

Example: **USER MENU**

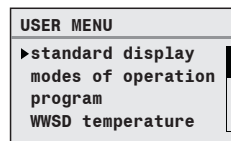

Action sequences: Sequences of steps are marked with a triangle with its point towards the text.

Example: ▶ Press .

If action sequences have more than two steps and the order of the steps is important, they are numbered (1., 2., ...).



Note on using this manual: Section 4.2 "Introduction to the Service menu" explains in detail the steps needed for programming all the settings in the Service menu. In the sections which come after it, programming is only explained in outline.

1.2 Safety instructions

Installation and commissioning

- ▶ Observe all instructions to ensure satisfactory operation.
- ▶ Read and observe the safety information and codes of conduct.
- ▶ Installation and commissioning must only be carried out by qualified and trained system installers.

Use

- ▶ Always use this device correctly and in conjunction with the stated control systems.
- ▶ Observe all regulations, standards, and codes applicable to installation and operation of the system in your country.

Risk of death from electric shock

- ▶ The electrical supply must be connected by a qualified electrician. The terminal diagram must be followed.
- ▶ Before installation: isolate all poles of the power supply (120 V AC).
- ▶ Do not install this device in rooms with high moisture exposure (e.g. bathrooms, saunas).
- ▶ Never directly connect this device to the 120 V AC power mains.

Risk of scalding at the taps

- ▶ Make sure that a thermostatic mixing valve is installed and that it is set to temperatures below 122 °F (50 °C).

Warning: frost

The heating system can freeze up in cold weather, if switched OFF or locked out.

- ▶ Leave the heating system permanently switched ON.
- ▶ Enable frost protection.
- ▶ In the event of a fault: remedy the fault immediately.

Warning: device damage

The RC35 has no field serviceable parts inside. Attempt to open the housing will cause internal damage, render the device inoperable, and void the manufacturer's warranty.

- ▶ In case of system irregularities please consult the 7 "Diagnosis" and 10 "Troubleshooting" sections of this manual.

2 Product description

2.1 Correct use

The RC35 control unit is intended for the operation and control of Buderus heating systems in single and multi-family houses.

The boiler must be equipped with EMS (energy management system).

The user interface must not be used in conjunction with Logamatic 2000/4000 control units. We recommend that the heating system is always operated with a user interface (only emergency operation is possible without a user interface).

These instructions describe all the possible functions of the RC35. Some of these functions may not be available, depending on which boiler (burner control unit) is used. For more information, refer to the relevant chapter.

For information on the burner control units used, refer to the **DIAGNOSIS\VERSIONS** menu (→ page 45).

2.2 Certifications



This product has been tested and is certified for both the US and Canadian markets, and meets all applicable US and Canadian standards.

2.3 Package contents

- RC35 user interface
- Operating instructions
- Mounting and maintenance instructions
- Wall bracket, attachment kit

2.4 Technical specifications

	Unit	RC35
Power supply via bus system	V	16 V DC
Power consumption	W	0.3
Power consumption with backlight	W	0.6
Dimensions (width/height/depth)	inches (mm)	6"/3-1/2"/1-1/2" (150/90/32)
Weight	ounces (g)	8.2 (233)
Operating temperature	°F (°C)	32 – 122 (0 – 50)
Storage temperature	°F (°C)	32 – 158 (0 – 70)
Relative humidity	%	0 – 90

Tab. 2 Specifications for the RC35 user interface

Temperature sensor characteristics

When measuring the resistance of temperature sensors, observe the following requirements:

- Isolate from the system before measuring.
- Measure the resistance at the cable ends.
- The resistances represent mean values and are subject to tolerances.

Outdoor temperature sensor		Supply temperature sensor			
		DHW temperature sensor			
°F (°C)	k Ω	°C	k Ω	°C	k Ω
-4 °F (-20 °C)	96.358	50 °F (10 °C)	19.872	140 °F (60 °C)	2.490
5 °F (-15 °C)	72.510	59 °F (15 °C)	15.699	149 °F (65 °C)	2.084
14 °F (-10 °C)	55.054	68 °F (20 °C)	12.488	158 °F (70 °C)	1.753
23 °F (-5 °C)	42.162	77 °F (25 °C)	10.001	167 °F (75 °C)	1.481
32 °F (0 °C)	32.556	86 °F (30 °C)	8.060	176 °F (80 °C)	1.256
41 °F (5 °C)	25.339	95 °F (35 °C)	6.535	185 °F (85 °C)	1.070
50 °F (10 °C)	19.872	104 °F (40 °C)	5.331	194 °F (90 °C)	0.915
59 °F (15 °C)	15.699	113 °F (45 °C)	4.372	203 °F (95 °C)	0.786
68 °F (20 °C)	12.488	122 °F (50 °C)	3.606	212 °F (100 °C)	0.677
77 °F (25 °C)	10.001	131 °F (55 °C)	2.989		
86 °F (30 °C)	8.060				

Tab. 3 Resistances of the 10 k Ω temperature sensors, for EMS only

2.5 Applicability of these instructions for function modules (accessories)

These instructions also apply to the user interface when used in conjunction with the MM10 mixing module and the WM10 low loss header module.

If the heating system is equipped with other function modules (e.g. SM10 solar module), additional settings and menus become available. Please see the instructions included with the module for details.

2.6 Accessories

For detailed information on suitable accessories, refer to the catalogue.

- MM10 mixing module for controlling a 3-way mixing valve
- WM10 low loss header module
- Solar module and other EMS modules
- Outdoor temperature sensor, separate room temperature sensor

3 Installation

3.1 Choosing the right installation location

3.1.1 Installation in reference room

If the system is room-temperature controlled, the following requirements must be met:

- Installation on an internal wall (→ Fig. 1).
- Maintain the specified distance from door(s) (to avoid drafts).
- Allow clearance below the user interface (→ Fig. 1, shaded area) (to ensure correct temperature measurement).
- The reference room (= installation room) must be as representative as possible of the entire home (or zone) if possible. External heat sources in the reference room (like sunlight or an open fireplace) affect the control's function. This means it may be too cold in rooms without those external heat sources.
- The thermostatic valves on the radiators (if installed) in the reference room must always stay fully open so that the two temperature controls do not affect one another.



If there is no suitable reference room, we recommend setting the system to outdoor temperature control instead (this requires an outdoor sensor). Alternatively, you could install an external room temperature sensor in the room with the greatest heating requirements (e.g. living room).

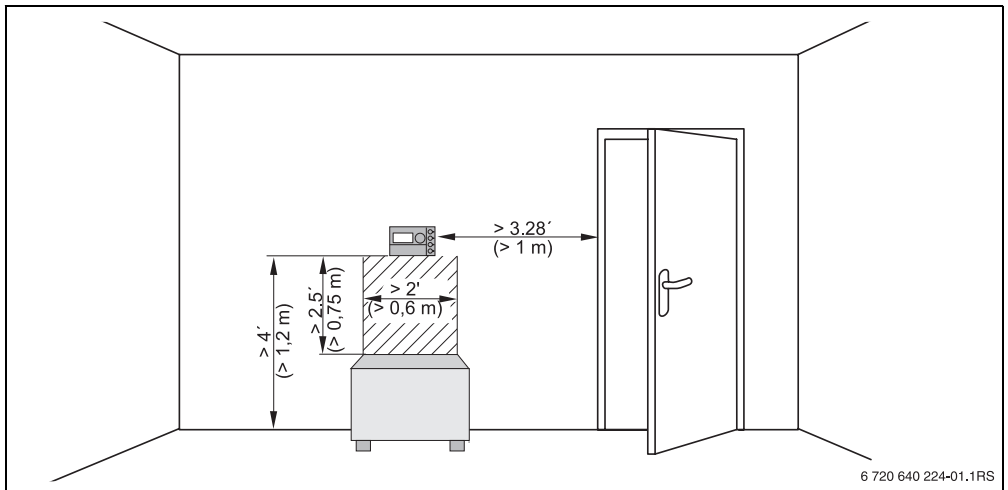

Fig. 1 Minimum clearances for mounting in a reference room

3.1.2 Installation on boiler

The unit can be installed directly on boilers equipped with EMS.

3.2 Types of installation

The user interface can be installed in three different ways:

- As the only user interface in the system (factory setting): the RC35 user interface is mounted in a room in the home (the reference room) or on the boiler.
Example: single-family house with one heating zone.
- As the only user interface in a heating system with two or more heating zones (→ Fig. 2).
Examples: radiant floor heating on one story, radiators in the other.

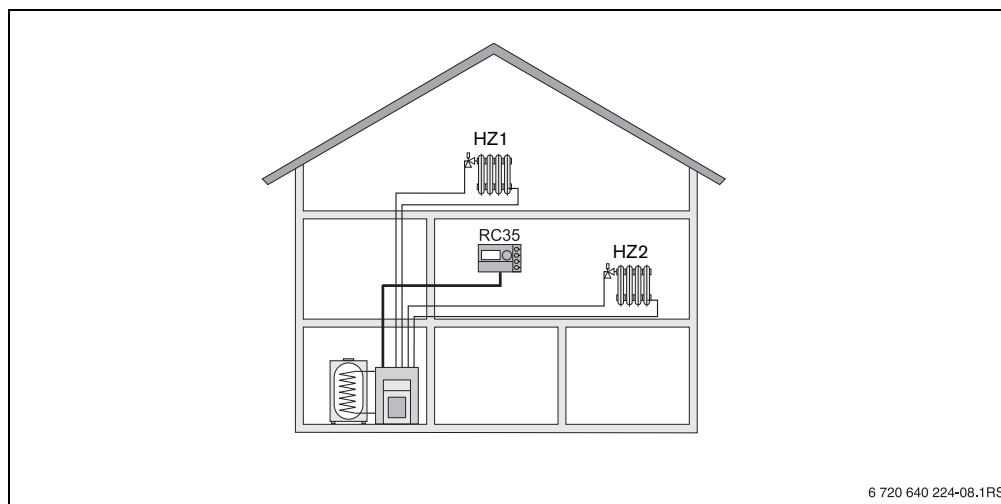

6 720 640 224-08.1RS

Fig. 2 Options for a heating system with two heating zones

3.3 Installation and connection



Please use only the wall bracket with screw terminals.

- ▶ If a wall bracket without screw terminals is already installed, replace it.

The wall bracket can be attached directly to the wall.

- ▶ Mount the wall bracket (→ Fig. 3, left).
- ▶ Connect the two-wire bus cable from the Energy Management System (EMS) to the “RC” cable terminals (→ Fig. 3, [3]).
 - Cable type: AWG18 (8 ft² (0.75 mm²)), length max. 330 ft. (100 m)
 - The two wires are not polarity sensitive.
 - Never route the cables next to power cables.

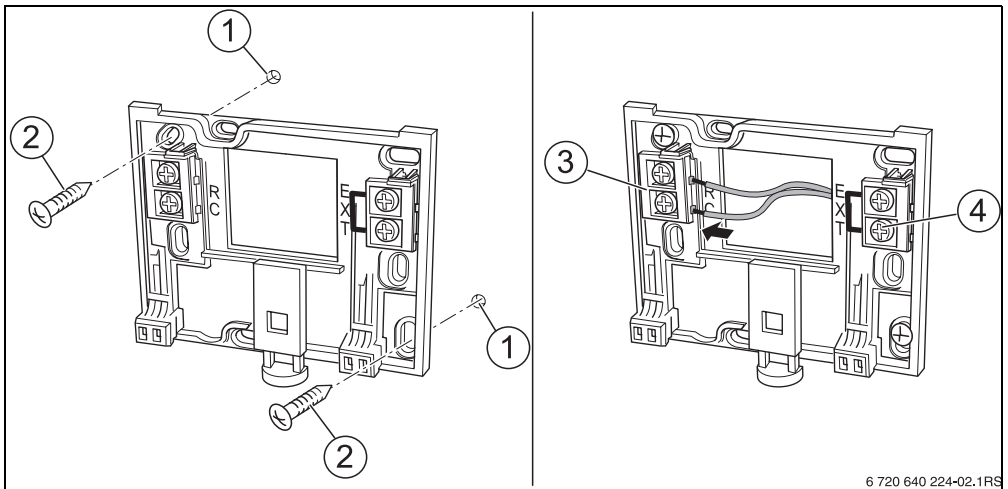

Fig. 3 Mounting the wall bracket (left) and connecting the wires (right)

- 1 Hole drilled in the wall
- 2 Screws (included with the unit) for surface-mounting on the wall
- 3 “RC” terminals for EMS (boiler)
- 4 “EXT” terminals for external room temperature sensor or for jumper

- ▶ If the RC35 is operated without an external room sensor, a jumper is needed on the “EXT” terminals (→ Fig. 3, [4]) (the jumper is factory-installed).
- ▶ If the RC35 is operated with an external room temperature sensor (optional), the factory-installed jumper on “EXT” must be removed and the external room temperature sensor must be connected there instead.

3.4 User interface: attaching or removing

Attaching the user interface

1. Hook the user interface at the top into the mounting plate in the direction of the arrow.
2. Push the user interface at the bottom against the mounting plate, until it snaps into place.

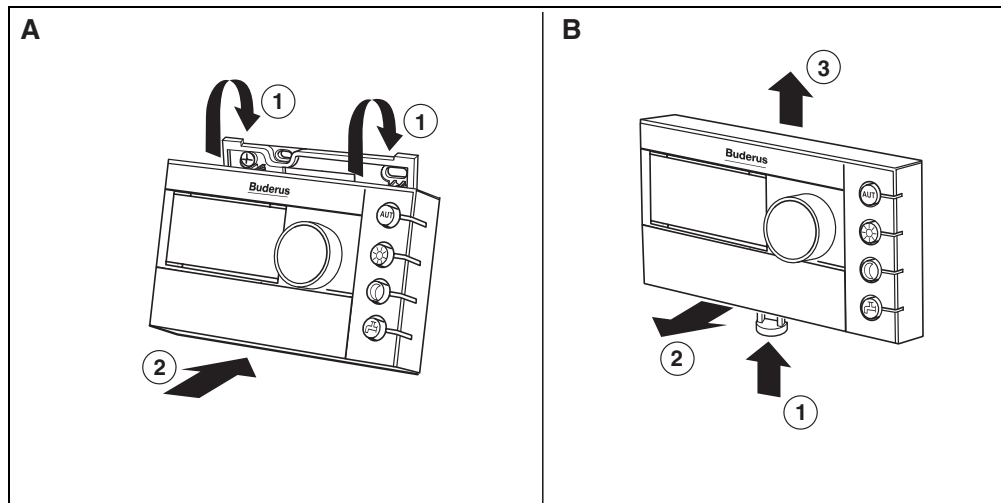

Fig. 4 Attaching the user interface (left) or removing it (right)

Removing the user interface

1. Press the button underneath the mounting plate in the direction of the arrow.
2. At the same time pull the user interface forwards.
3. Remove the user interface by lifting upward.

4 Operating basics

4.1 Overview of operation



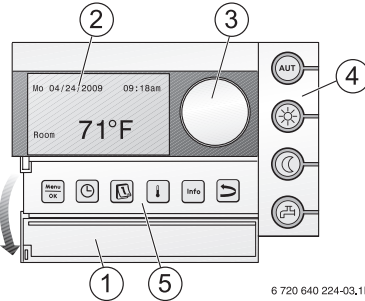

Legend for figure:

- 1 Cover: Pull the recessed grip on the left to open
- 2 Display
- 3 Dial for changing values and temperatures or for navigating through the menus



6 720 640 224-03,1RS







4 Buttons for basic functions:

-  "AUT" (automatic)
-  "Day mode" (manual)
-  "Night mode" (manual)
-  "DHW" (domestic hot water)

When the LED lights up ...

- ... the program is active (automatic switchover between day and night room temperatures).
- ... the heating system operates at the set day room temperature. DHW heating is switched on (factory setting).
- ... the heating system operates at the set night setback room temperature. Frost protection is active. DHW heating is switched OFF (factory setting).
- ... the DHW temperature has fallen below its set value while in setback mode. The DHW can be heated up again (single change) by pressing the button (the LED will then flash).









5 Buttons for additional functions:

-  "Menu/OK" **Function:**
Open the user menu and confirm the current selection. Turning the dial while pressing the button will change the value.
-  "Time" **Function:**
Set the time.
-  "Date" **Function:**
Set the date.
-  "Temperature" **Function:**
Set the room temperature.
-  "Info" **Function:**
Open the Info menu (to view values).
-  "Back" **Function:**
Go back one step or one menu item.







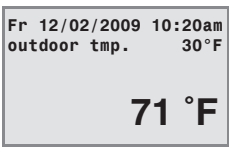

In Automatic mode, an additional LED lights up with the "AUT" LED to indicate which operating status is currently active ("day mode" or "night mode"). The "domestic hot water" LED can also be disabled.

4.2 Introduction to the Service menu



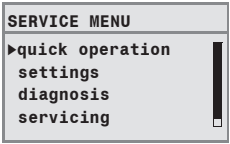

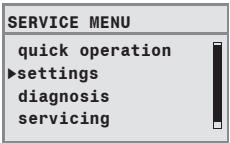

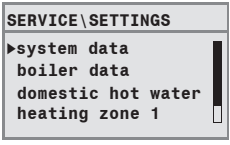

The **SERVICE MENU** sets the system parameters. The Service menu also contains fault diagnosis, for maintenance purposes, and performing a reset. The procedure for operation is always the same:

1. Open the cover (by pulling the recessed grip on the left).
 2. Simultaneously press the  +  +  buttons to open the **SERVICE MENU**.
 3. Turn the dial  to change the selected item (marked with ▶).
 4. Press  to make your selection.
 5. To change the value, hold down the  button (the value starts flashing) and turn the dial  at the same time.
Release the button: the changed value is saved.
 6. Press  to go back one step.
- or-**
7. Press  several times or shut the cover to return to the default display.

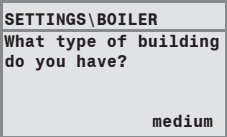
Example: Setting the **type of building** (“delay” time)

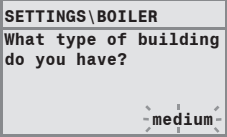
	Operating Instructions	Result
1.	Open the cover (by pulling the recessed grip on the left).	
2.	Simultaneously press the  +  +  buttons to open the SERVICE MENU .	
3.	Turn the dial  counter-clockwise until settings is selected (marked with ▶).	
4.	Press  to confirm the selection. The SERVICE\SETTINGS menu is opened.	

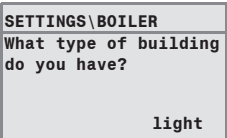
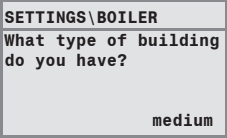
Tab. 4 How to use the Service menu (example)

	Operating Instructions	Result
5.	Turn the dial  counter-clockwise until system data is selected (marked with ▶). Press  to select system data.	
6.	To change the value, hold down the  button (the value starts flashing) and turn the dial  at the same time.	
7.	Release the  button. The value stops flashing. The modified value is saved.	
8.	If you have carried out this example as practice only, make sure that the original setting is retained. To do so, repeat steps 6 and 7 if necessary.	
9.	Press  to go back one step. -or- To finish entering settings,  shut the cover. The standard display reappears.	
You can enter all settings in the SERVICE MENU using this procedure.		

Tab. 4 How to use the Service menu (example)

4.3 Overview of the Service menu

The **SERVICE MENU** is divided into the following menus and submenus:

Menu	Submenu	Contents/function	Page
quick operation		The most important parameters from the "settings" menu for configuration of the heating system	20
settings (all parameters)	system data ¹⁾	Parameters: language, number of heating zones, installed modules, building type, minimum outdoor temperature	24
	boiler data ¹⁾²⁾	Parameters: pump after-run time and modulation	27
	heating zone data ¹⁾	Parameters of the installed heating zones	28
	domestic hot water (DHW) ¹⁾	Parameters for domestic hot water	37
	solar data ²⁾	If solar is installed: see documentation for the solar module	39
	RC35 calibration	Parameters: calibration of the displayed room temperature	40
	contact data	Entering the heating contractor's name and telephone number	41
diagnosis	functional test ¹⁾²⁾	Activating individual components for test purposes	42
	monitor value	Viewing target values and actual values	43
	error message ¹⁾	Viewing fault messages	44
	heating curve	Viewing the set heating characteristics in the form of a graph	45
	versions	Viewing software versions	45
servicing ¹⁾²⁾	service interval	Setting times for maintenance, by number of operating hours or by date	46
	current messages	Viewing service messages	46
	RESET service	Resetting service messages	46
RESET ¹⁾	factory default set	Reset all parameters	47
	fault list		47
	service message		47
	run time		47







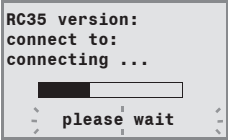

Tab. 5 Service menu navigator

1) Subject to restrictions depending on which boiler is used.

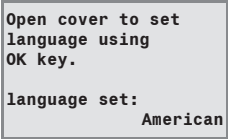
2) Not possible or not available, depending on the boiler used.

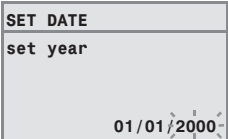
5 Commissioning

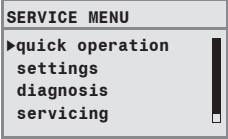

5.1 General commissioning

	Operation	Result
1.	<p>Switch on the heating system.</p> <p>While setting up the connection between the RC35 and EMS the display shows the message on the right.</p> <p>If the display shows a different message, look it up in section 10, page 48.</p>	 <p>RC35 version: connect to: connecting ... please wait</p>
2.	<p>Set the language:</p> <p>Open the cover. Hold down the  button and use the dial to set the language.</p>	 <p>Open cover to set language using OK key. language set: American</p>
3.	<p>Set the date and time:</p> <p>Hold down the  button and use the dial to set the values that are flashing. Release the button.</p> <p>Hold down the  button and use the dial to set the values that are flashing. Release the button.</p> <p>In the event of a power failure, the date and time are retained for up to 8 hours. All other settings are retained permanently.</p>	 <p>SET DATE set year 01/01/2000</p>
4.	<p>Simultaneously press the  +  +  buttons to open the SERVICE MENU.</p>	 <p>SERVICE MENU quick operation settings diagnosis servicing</p>

Tab. 6 General commissioning



If necessary, you can change the contrast on the display:

- ▶ Hold down the  and  buttons and turn the dial  at the same time.

5.2 Checklist: important parameters for commissioning

When putting the device into service, ensure that the heating system settings meets the customer's needs and expectations. In our experience, the following parameters are very important for the satisfaction of the system owner.

- Find out the system owner's requirements and preferences regarding ...

	Input range	Factory setting	Service menu\ Settings\
... the desired setback mode (night setback)	Outdoor setback mode Room setback mode setback mode shutdown operation	Outdoor setback mode	heating zone x, page 29
... the desired control mode	outdoor reset control room reset control	outdoor reset control	heating zone x, page 32
... the correct heating characteristics	By means of the following parameters: standard temperature, minimum outdoor temperature, offset, and target room temperature		heating zone x, page 28
... the correct type of building ("delayed" response to outdoor temperature)	light medium heavy	medium	system data, page 25
... the switch-on frequency of the DHW circulation pump	Permanent, 1 x, 2 x, 3 x, 4 x, 5 x, 6 x per hour for 3 min each time	2 x	domestic hot water, page 38
... DHW Priority	yes no	yes	heating zone x, page 30
... program (times)	Standard program e.g. family, custom program	family	heating zone x, page 31

Tab. 7 Checklist: important parameters for commissioning

5.3 Quick commissioning (Quick operation menu)

► Press  to open the **quick operation** menu.

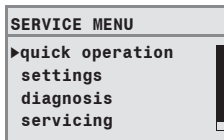

SHORTCUT	Menu item	Input range	Factory setting	Other information
BASIC SETUP	Which language should be used?	American, French, Spanish	American	
LOW LOSS HEADER	Did you install a low loss header module?	yes, no	no	In connection with MCM10 the setting is set automatically to "yes"; the screen disappears.
UNMIXED HZ	Is heating zone 1 installed (unmixed heating zone)?	yes, no	yes	
# OF MIX VALVES	How many mixed heating zones are installed?	0 to 3	0	Set the address on the dial on the MM10 mixing module (factory setting: HZ2).
HEATING ZONE 1 (and other heating zones)	Which user interface is assigned to heating zone 1?	RC20, RC35 none	RC35	To assign user interface to heating zone (→ page 32).
	How should heating zone 1 be controlled?	outdoor reset, room reset	outdoor reset	General heating zone data (→ page 28). Set any other heating zones in the same way as for heating zone 1.
	Which heating system does heating zone 1 have?	panel radiator, convector, floor	panel radiator	Heating characteristic curve (→ page 33)

Tab. 8 Quick operation menu navigator

SHORTCUT	Menu item	Input range	Factory setting	Other information
DHW	Is a DHW tank installed?	yes, no	no	
	What should be used for domestic hot water heating?	low loss header, tank charging pump	low loss header	
	Please select the domestic hot water temperature.	90 to 176 °F	140 °F	To allow the hot water temperature to be changed, set the hot water dial on the boiler controller to Aut.
SOLAR MODULE	Has a solar module been installed?	yes, no		

Tab. 8 Quick operation menu navigator



Use the checklist on page 19 to check whether more settings are needed.

5.4 Detailed commissioning

- ▶ Check whether the factory settings in the **SERVICE\SETTINGS** menu are suitable for the customer's heating system.
- ▶ Write down modified settings for future reference in the Set Up Log.

5.5 System commissioning

- ▶ Make sure that both dials on the BC10 boiler controller are set to "Aut", so that DHW temperature and supply temperature are controlled by the RC35.
- ▶ Explain to the customer how the device works and how to operate it.
- ▶ Inform the customer of the settings chosen.



We recommend giving these installation and servicing instructions to the customer so they can be kept close to the heating system.

5.6 Shut-down/switching off

The RC35 controls is supplied with power via the heating system and is permanently switched on. It is only switched off if the heating system is switched off, such as for maintenance purposes.

- ▶ To switch the heating system on or off: set the ON/OFF switch on the boiler to position 1 (ON) or 0 (OFF).



After switching the unit OFF or in the event of a power failure, the date and time are retained for up to 8 hours. All other settings are permanently memorized.

5.7 Operating tips

Devices on the EMS bus

In a bus system, only one device can carry out the calculations for a heating zone. Therefore only one RC35 can be installed in a heating system. If additional room controllers are needed, they are installed as remote control units with a designated heating zone (→ page 28).

Thermostatic radiator valves in the reference room

With room temperature control, thermostat valves do not need to be installed on the radiators in the reference room¹⁾. If there are thermostatic radiator valves in the reference room, they must be fully open at all times.

Pump anti-seize Feature

In all operating modes, all heating zone pumps are switched on for 10 seconds every Wednesday at 12 noon to prevent pump damage. The mixing valves are then set to "OPEN" for 10 seconds and then to "CLOSE". After 10 seconds, all pumps and mixing valves then return to their normal, regulated operation.

1) Room in which an RC35 is installed.

6 Entering system settings (Service menu – Settings)

- ▶ Simultaneously press the  +  +  buttons to open the **SERVICE MENU**.
- ▶ Turn the dial  counter-clockwise until **settings** is selected (marked with ▶).
- ▶ Press  to open the **SERVICE\SETTINGS** menu.

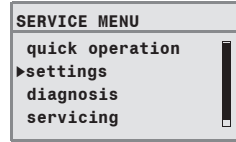

Note that the menu items shown will vary depending on the heating system.

6.1 System data

- ▶ Press  to select **system data**.
The **SETTINGS\SYSTEM** menu opens.

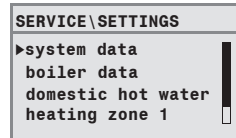

Menu item	Input range	Factory setting	Other information
Which language should be used?	American, French, Spanish	American	
Choose units of measurement.	US		customary units °F, metric °C/bar
Choose time format:	am/pm		24h
Choose date format:	MM/DD/YYYY		DD/MM/YYYY
Did you install a low loss header module?	yes, no	no	In connection with MCM10 the setting is set automatically to "yes"; the screen disappears.
Is heating zone 1 installed (unmixed heating zone)?	yes, no	yes	
How many mixed heating zones are installed?	0 to 3	0	Set the address on the dial on the MM10 mixing module (factory setting: HZ2).
Has a solar module been installed?	yes, no	no	

Tab. 9 Navigator for Service menu SETTINGS\SYSTEM

Menu item	Input range	Factory setting	Other information
Confirm disabling the use of the calculated outdoor temperature.	yes, no	no	If "yes", the following parameter (building type) is not shown.
What type of building do you have?	light, medium, heavy	medium	For type of building (heat storage capacity) (→ page 25).
What is the design day temperature in your region?	-40 °F – 32 °F (-40 °C – 0 °C)	-14 °F	(→ page 26)

Tab. 9 Navigator for Service menu SETTINGS\SYSTEM

6.1.1 Type of building (“damping” of outdoor temperature)

A building's heat storage capacity and its characteristic resistance to heat transfer will delay the effect of outdoor temperature variation on the rooms inside. As a consequence, it is not the current outdoor temperature that is crucial to the heat demand of rooms, but the so-called “adjusted outdoor temperature”.

The building type parameter can be used to set the level of delay with which variations in outdoor temperature are registered. This allows the heating system control adapt to the characteristic behavior of the building.

The controls calculates the time constant for the delay in response to the outdoor temperature

Parameter: building type	Type of construction
light	Buildings with small heat storage capacity and low to medium levels of insulation, e.g. 2x4 wood frame or prefabricated construction with typical insulation.
medium	Buildings with medium heat storage capacity and high levels of insulation, e.g. 2x6 wood frame or cinder block construction with above average insulation (factory default).
heavy	Massive buildings with high heat storage capacity and high levels of insulation, e.g. poured concrete, heavy brick or heavy cinder block construction with excellent insulation.

Tab. 10 Calculating the damping time constant

Example:

Fig. 5 This greatly simplified example shows how the delayed response to outdoor temperature follows the outdoor temperature, but does not reach its extreme values.

- 1 Current outdoor temperature
- 2 Adjusted outdoor temperature



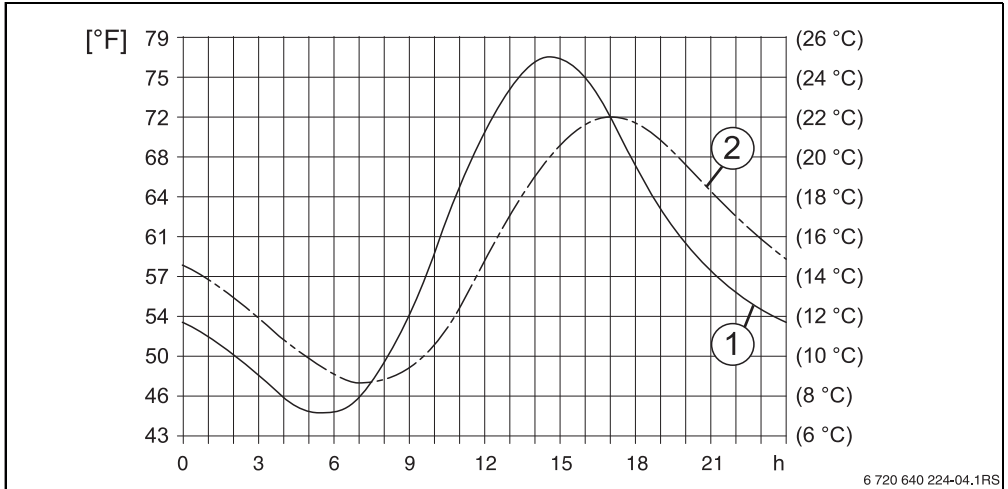

With the factory setting, changes in the outdoor temperature will affect the calculations for outdoor-temperature-based control after a delay of no more than three hours (30 x 6 minutes = 180 minutes).

- ▶ To monitor the calculated, delayed response to outdoor temperature and the currently recorded outdoor temperature:
open the menu **Diagnosis\Monitor\boiler/burner**.

6.1.2 Minimum outdoor temperature

The “minimum outdoor temperature” is the mean of all the coldest outdoor temperatures of recent years, and helps to determine the heating characteristics. The value can be taken from the heat requirement calculation that should be done for every building, or from the climatic zone chart of your region.

6.2 Boiler data

- ▶ Turn the dial  counter-clockwise until **boiler data** is selected (marked with ▶).
- ▶ Press  to select **boiler data**.
The **SETTINGS\BOILER** menu opens.

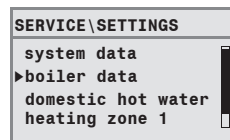



Menu item	Input range	Factory setting	Other information
Set boiler pump post purge after burner stops?	deactivated, 1 to 60 min, 24 hours	5 min	Setting only possible with boilers with internal boiler pump.
Please adjust modulating pump settings.	0 to 8	2	Characteristics of the boiler pump depend on the boiler installed <ul style="list-style-type: none"> • 0: if a hydraulic low loss header has been installed • 1 – 8: see boiler documentation¹⁾

Tab. 11 Navigator for Service menu SETTINGS\BOILER

1) system-dependent

6.3 Heating zone data

This section explains the settings for all heating zones: using heating zone 1 as an example.

- ▶ Turn the dial  counter-clockwise until **heating zone 1** is selected (marked with ▶).
- ▶ Press  to select **heating zone 1**.
The **SETTINGS\HTG. ZONE 1** menu opens.

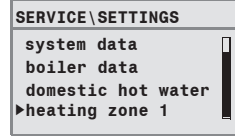

Menu item	Input range	Factory setting	Other information
Should heating zone 1 be activated?	yes, no	yes	
Which user interface is assigned to heating zone 1?	none, RC20, RC35	RC35	(→ page 33) If none is selected, the control mode is changed to outdoor reset and will not be shown.
How should heating zone 1 be controlled?	outdoor reset, room reset	outdoor reset	Room reset can only be set if an RC20 or RC35 has been assigned to the heating zone. If there is one unmixed zone on a system with a modulating burner, the boiler power will be used to directly control the room temperature; in all other cases the supply temperature will be controlled.
Which heating system does heating zone 1 have?	panel radiator, convector, floor	panel radiator	With HZ1, only use the floor setting if the boiler is a gas condensing boiler. Additional heating zones can then be installed. A safety thermostat must be used with radiant floor heating regardless.
Heating curve			
Design tmp 14 °F (-10 °C)	84 °F to 194 °F (30 °C – 90 °C)	167 °F (75 °C) (panel radiator, convector) 113 °F (45 °C) (floor)	Setting entered only if the control mode has been set to outdoor reset (→ page 33).

Tab. 12 Navigator for Service menu SETTINGS\HTG. ZONE 1

Menu item		Input range	Factory setting	Other information
	max.supply temp.	panel radiator, convector: 86 °F – 194 °F (30 °C – 90 °C)	panel radiator, convector: 167 °F (75 °C)	Setting entered only if the control mode has been set to outdoor reset (→ page 32)
	Enter the maximum supply temperature:	floor: 86 °F – 140 °F (30 °C – 60 °C)	floor: 122 °F (50 °C)	Setting entered only if the control mode has been set to room temp. controlled (→ page 32).
	min.supply temp.	41 °F – 158 °F (5 °C – 70 °C)	41 °F (5 °C)	Setting entered only if the control mode has been set to outdoor reset (→ page 32)
	Enter the minimum supply temperature:			Setting entered only if the control mode has been set to room temp. controlled (→ page 32).
	room tmp.offset	-9 °F – +9 °F (-5 °C – +5 °C)	0 °F (0 °C)	Parallel shifting of characteristic heating curve. Setting entered only if the control mode has been set to outdoor reset (→ page 32)
	Enter the maximum room influence:	0 °F – 18 °F (0 °C – 10 °C)	0 °F (0 °C)	Setting entered only if the control mode has been set to outdoor reset (→ page 32)
	Select the type of setback:	Outdoor setback mode, setback operation, Room setback mode (only if RC35 or RC20 has been assigned to the heating zone)	Outdoor setback mode	Night setback (→ page 34)
	What outdoor temp. should be used for setback operation?	-4 °F – +50 °F (-20 °C – +10 °C)	41 °F (5 °C)	Temperature threshold for outdoor setback mode (→ page 34). Setting entered only if the reduction mode has been set to outdoor setback mode.
Frost protection				
	Set temperature for frost protection.	outdoor temperature no frost protection room temperature	outdoor temperature	Room temperature can only be set if RC20 or RC35 has been assigned to the heating zone (→ page 35).

Tab. 12 Navigator for Service menu SETTINGS\HTG. ZONE 1

Menu item		Input range	Factory setting	Other information
	Set temperature for frost protection.	-4 °F – +50 °F (-20 °C – +10 °C)	41 °F (5 °C)	Refers to outdoor temperature (→ page 35).
	At what outdoor temp. should the setback be canceled?	OFF, -22 °F – 50 °F (-30 °C – +10 °C)	OFF	
	Confirm activating DHW priority.	yes, no	no	
Mixing valve				
	Is a mixing valve installed?	yes, no	yes	Can only be set for heating zones 2 and up.
	What is the run time of the mixing valve?	10 – 600 seconds	120 seconds	
	What increase should be used for the boiler?	0 °F – 36 °F (0 °C – 20 °C)	10 °F (5 °C)	
Drying floor radiant slab				
	Confirm running a slab drying cycle.	yes, no	no	Can only be set if radiant floor heating has been entered as the heating system. DHW heating is disabled while slab is drying.
	Set the frequency for raising the supply temperature.	every day, every 2nd day to every 5th day	daily	
	Set the supply temperature increase.	0 °F – 72 °F (0 K – 40 K)	9 °F (5 °C)	
	Set the maximum supply temperature.	77 °F – 140 °F (25 °C – 60 °C)	113 °F (45 °C)	
	For how many days should max. supply temp. be maintained?	0 – 20 days	4 days	

Tab. 12 Navigator for Service menu SETTINGS\HTG. ZONE 1

Menu item	Input range	Factory setting	Other information
Set the frequency for reducing the supply temperature.	direct normal operat., every day, every 2nd day to every 5th day	every day	
Set the supply temperature decrease.	0 °F – 36 °F (0 °C to 20 °C)	9 °F (5 °C)	Can only be set if direct normal operat. has not been entered for supply temperature reduction.
Confirm changing the program?	yes, no	no	Selecting “yes” takes you to the program for the heating zone.
Should the program be optimized?	yes, no	no	Switch-on and switch-off times are automatically adjusted according to the outdoor temperature, room temperature and building type (heat storage capacity).
What setback mode should be used for vacation / absence?	Outdoor setback mode Room setback mode setback mode shut-down mode	Outdoor setback mode	→ page 34. Room setback mode can only be set if a remote control unit (e.g. RC20) has been assigned to the heating zone. If setback mode is selected the normal night temperature is used.
What outdoor temp. should be used in vacation mode?	–4 °F – +50 °F (–20 °C – +10 °C)	41 °F (5 °C)	Temperature threshold for outdoor setback mode (→ page 34). Setting entered only if the reduction mode for vacation has been set to Outdoor setback mode.

Tab. 12 Navigator for Service menu SETTINGS\HTG. ZONE 1

6.3.1 Assignment of user interface/remote control unit in the software

Example: heating system with heating zone 1 and heating zone 2 (→ page 11)

Alternative	Setting: Which remote control is assigned to the heating zone?	Effect
A	HZ 1 = RC35, HZ 2 = RC35 (→ Fig. 2, [1], page 11)	Same room temperatures for HZ 1 and HZ 2
B	HZ 1 = RC35, HZ 2 = none (→ Fig. 2, [1], page 11)	Room temperatures for HZ 1 and HZ 2 can be set separately

Tab. 13 Settings for room temperature depending on user interface

6.3.2 Control mode (outdoor temperature controlled/room influence)

The temperature of the heating water in the boiler is defined by the heating characteristics determined in the Logamatic controls. A selection can be made whether these heating characteristics will be influenced solely by the outdoor temperature, or by a combination of outdoor temperature and room temperature.

- Outdoor temperature controlled:** The boiler temperature calculated in the controls will be controlled by variation in the “delayed” response to outdoor temperature in combination with selected settings for target room temperature, offset, standard temperature and minimum outdoor temperature. This temperature is then delivered to the radiators or radiant floor heating by means of permanent operation of the heating zone pump. The only situations in which this setting could result in shut-down of the heating zone pump are summer operation, night setback (depending on the reduction mode selected) or DHW mode (only with domestic hot water priority).
- Outdoor temperature controlled, influenced by room temperature** (factory default): this form of control works in exactly the same way as pure outdoor temperature control, except that you can use the **maximum room influence** parameter to determine whether and to what extent the room temperature should influence the heating characteristics. The remote control unit must be installed in a reference room, so that a representative room temperature is recorded. The greater the parameter set, the greater the influence of the room temperature on the heating characteristics (factory setting: 0 °F (0 °C)). This applies when the room temperature exceeds or falls below the target room temperature. If the **maximum room influence** parameter is set to **0**, the heating characteristics will be controlled solely by outdoor temperature.

6.3.3 Characteristic heating curve

Parameters: Standard temperature, maximum and minimum supply temperature and room temperature offset (parallel shifting of characteristic heating curve)

The characteristic heating curve forms the basis for economical and easy operation of the heating system with outdoor reset. To calculate the characteristic heating curve, the Logamatic control uses a number of parameters.

This calculation takes into account the “delayed” response to outdoor temperature changes and the room temperature. The room temperature is internally calculated, based on target room temperature and the room influence factor.

This allows the user to influence the heating characteristics directly by modifying the target room temperature.

The heating characteristic curve (→ Fig. 6, page 34) is determined by the base point and end point. The base point is located at 14 °F (–10 °C) supply temperature at a room temperature of 68 °F (20 °C). The end point of the heating characteristic curve must be set in accordance with the design temperature of the heating system.

The gradient of the heating characteristic curve (the shape of the curve) is determined by the parameters **minimum outdoor temperature** (the lowest outdoor temperature expected in a particular region, → page 26) and the **standard temperature** (the supply temperature which should be reached when the outdoor temperature is at minimum) (→ Fig. 6, left).



The x-axis of the heating characteristic curve shown on the display covers the range from +68 °F to –4 °F (+20 °C to –20 °C). With the parameter std. tmp., the minimum outdoor temperature is represented by a circle. However, the diagram will not be quite correct if a minimum outdoor temperature below –4 °F (–20 °C) is entered (the circle will no longer be on the heating characteristic curve).

The **minimum supply temperature** parameter can be used to define a minimum target value (→ Fig. 6, [4]). If the temperature falls below this value, the burner is fired.

The characteristic heating curve can be shifted, up or down, in parallel to the original curve, by adjusting the **room temperature offset** parameter and/or the set room temperature (→ Fig. 6, right). This feature should be used if, for example, the room temperature measured with a thermometer differs from the set target value.

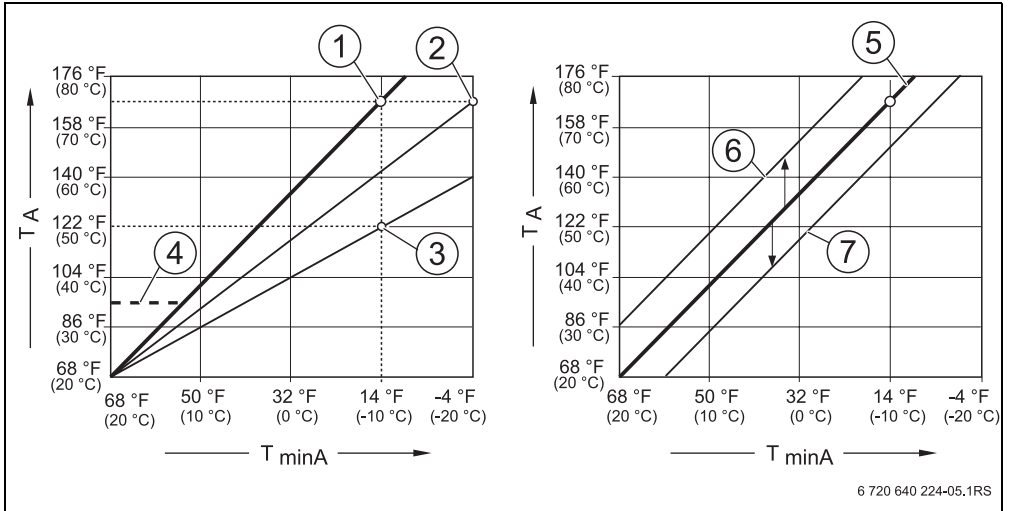

Fig. 6 Setting the characteristic heating curve
 Left: setting the gradient by means of standard temperature and design day temperature
 Right: parallel shift possible by means of offset or target room temperature

$T_{\min A}$ Minimum outdoor temperature

T_A Standard temperature (i.e. the design temperature – the supply temperature to be reached at design day temperature)

- 1 Setting: design temperature 167 °F (75 °C), minimum outdoor temperature 14 °F (-10 °C) (base curve)
- 2 Adjustment: Design temperature 167 °F (75 °C), minimum outdoor temperature 4 °F (-20 °C)
- 3 Adjustment: Design temperature 122 °F (50 °C), minimum outdoor temperature 14 °F (-10 °C)
- 4 Setting: minimum supply temperature 95 °F (35 °C)
- 5 Setting: design temperature 167 °F (75 °C), minimum outdoor temperature 14 °F (-10 °C) (base curve)
- 6 Parallel shifting of base curve by changing the offset +6 °F (+3 °C) or by increasing the target room temperature
- 7 Parallel shifting of base curve by changing the offset -6 °F (-3 °C) or by reducing the target room temperature

6.3.4 Reduction modes (night setback)

There are a number of different reduction modes available, which allow night setback to be adjusted to suit the differing needs of the user:

- **setback mode:** The rooms are maintained at a reasonable temperature by constant heating operation (the heating zone pump runs constantly). A target room temperature for nighttime can be set. This must be at least 2 °F (1 °C) lower than the daytime target room temperature. The heating characteristics will be calculated in accordance with this setting. This setting is recommended for radiant floor heating.

- **shut-down mode:** The boiler and the heating zone pump are switched off, and frost protection is activated. The heating zone pump runs only for purposes of frost protection. Not recommended if there is a risk that the building could cool down too much.
- **Room setback mode:** If the room temperature falls below the set night temperature (the target value), the heating system will operate in the same way as for reduced heating operation (as described under reduction mode “setback mode”). If the room temperature exceeds the target night temperature by more than 2 °F (1 °C), the boiler and the heating zone pump are switched off (as described under reduction mode “shut-down mode”). This reduction mode is only possible if a remote control unit has been installed in a representative room (the reference room) or if the room temperature is recorded using an external room sensor.
- **Outdoor setback mode:** If the “delayed” response to outdoor temperature falls below a user-defined threshold, the heating system will operate in the same way as for reduced heating operation (as described under “setback mode”). Above this threshold, the heating system will be switched off (as described under reduction mode “shut-down mode”). This reduction mode is suitable for heating zones that do not have their own remote control unit, and protects the rooms from cooling down too much once a certain outdoor temperature is reached.

6.3.5 Frost protection

The frost protection function comprises the following options:

- **no frost protection** (frost protection is switched off)
- **outdoor temperature** (outdoor temperature sensor required) If the outdoor temperature falls below the adjustable frost protection temperature threshold, the heating zone pump is switched on automatically.
- **room temperature** (room temperature sensor in the RC35 or RC20) If the room temperature falls below the fixed value of 41 °F (5 °C), the heating zone pump is switched on automatically. If the room temperature rises above 44 °F (7 °C), the heating zone pump is switched off automatically.



CAUTION: Risk of system damage due to freezing. The settings **no frost protection** and **room temperature** provide either no frost protection or inadequate frost protection. When these settings are selected, the display shows a message indicating the risk of freezing.

- ▶ For reliable frost protection, use the **outdoor temperature** setting.



The **room temperature** setting does not provide absolute frost protection because pipes laid in external walls (for example) could freeze even though the temperature in the reference room might be clearly above 41 °F (5 °C) due to external heat sources (fireplace etc.).

At what outdoor temperature should setback be cancelled?

In the parameter **At what outdoor temp. should the setback be canceled?**, you can set an outdoor temperature threshold (this threshold applies to the “delayed” response to outdoor temperature; → page 25).

Fig. 7 shows how the frost protection function works, without this parameter activated and with it activated. Settings selected: frost protection by **outdoor temperature; frost protection temperature 41 °F (5 °C)**.

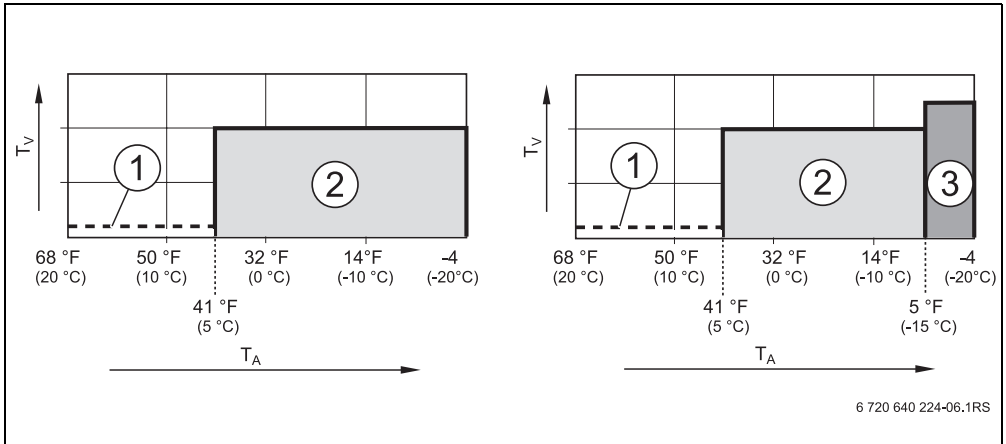



Fig. 7 Effects of the parameter “At what outdoor temperature should reduction be interrupted?”
 Left: parameter is set to “OFF” (factory setting)
 Right: parameter is set to 5 °F (-15 °C)

- T_A Outdoor temperature
- T_V Supply temperature
- 1 Shutdown operation
- 2 Reduced operation (at set nighttime room temperature)
- 3 Heating operation (at set daytime room temperature)



If the outdoor temperature falls below the set value of 6 °F (-15 °C), heating switches from reduced operation to heating operation (→ Fig. 7, [3]). This allows smaller heating surfaces to be utilized.

6.4 Domestic hot water (DHW)



WARNING: Risk of scalding at the taps.
 There is a risk of scalding at the taps whenever domestic hot water temperatures can be set to more than 122 °F (50 °C), and also during thermal disinfection.

- ▶ Make sure that a thermostatic mixing valve is installed and that it is set to temperatures below 122 °F (50 °C).

- ▶ Turn the dial  counter-clockwise until **domestic hot water** is selected (marked with ▶).
- ▶ Press  to select **domestic hot water**.
 The **SETTINGS\DHW** menu opens.

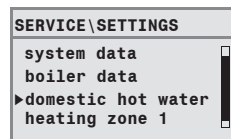

Menu item	Input range	Factory setting	Other information
Is a DHW tank installed?	yes, no	no	
Set maximum DHW temperature:	140 °F – 176 °F (60 °C – 80 °C)	140 °F (60 °C)	Depending on the boiler, the max. possible DHW target temperature is limited to 140 °F (60 °C).
Please select the domestic hot water temperature.	86 °F to 176 °F (30 °C – 80 °C)	140 °F (60 °C)	If the limit is set to > 140 °F (> 60 °C), it will be possible to set temperatures of that level in the User menu as well.
What should be used for domestic hot water heating?	Selection of 3-way switching valve vs tank primary pump	3-way valve	
Confirm changing the DHW program.	yes, no	no	Selecting “yes” takes you to the program for domestic hot water.
Recirculation			
Is a recirculation pump installed?	yes, no	no	

Tab. 14 Navigator for Service menu SETTINGS\DHW

Menu item		Input range	Factory setting	Other information
	Specify the frequency of the recirculation pump per hour.	once for 3 minutes, twice for 3 minutes, 3 times for 3 minutes, 4 times for 3 minutes, 5 times for 3 minutes, 6 times for 3 minutes, permanent operation	twice for 3 minutes	
	run recirc pump			Graphical display of number of times the pump is switched on per hour.
	Confirm changing the recirculation program.	yes, no	no	Selecting “yes” takes you to the program for hot water circulation.
Thermal disinfection				
	Confirm performing a thermal disinfection.	yes, no	no	
	Set thermal disinfection temperature.	140 °F – 176 °F ¹⁾ (60 °C – 80 °C)	158 °F (70 °C)	At temperatures above 122 °F (50 °C) there is a risk of scalding at the taps during and after thermal disinfection.
	Set the day of the thermal disinfection.	Monday, Tuesday, Wednesday, Thursday, Friday, Saturday, Sunday, daily	Tuesday	
	Set the time of day of the thermal disinfection.	12:00 am – 11:00 pm	1:00 am	Times entered must be whole hours only (no minutes).
	Should the LED of the single charge key be activated?	yes, no	yes	The single charge function (for one-off heating of hot water) still works but is no longer indicated by an LED.



Tab. 14 Navigator for Service menu SETTINGS\DHW

1) Depending on the boiler, a fixed temperature is defined and it cannot be changed.

6.5 Solar data



In order for the solar menu to become available, under **SETTINGS\SYSTEM** the question: "Has a solar module been installed?" must be answered with "yes".

- ▶ Turn the dial  counter-clockwise until **solar data** is selected (marked with ▶).
- ▶ Press  to select **solar data**.
The **SETTINGS\SOLAR** menu opens.

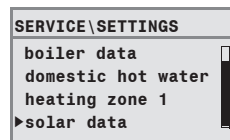



Menu item	Input range	Factory setting	Other information
Set the maximum solar tank temperature.	86 °F – 194 °F (30 °C – 90 °C)	140 °F	
Set the minimum solar tank temperature.	86 °F – 130 °F (30 °C – 54 °C) OFF	OFF	
What is the minimum pump rating?	20 % – 100 %	30 %	

Tab. 15 Navigator for Service menu **SETTINGS\SOLAR**



For explanations of the settings, see the documentation for the SM10 solar module.

6.6 RC35 calibration

- ▶ Turn the dial  counter-clockwise until **RC35 calibration** is selected (marked with ▶).
- ▶ Press  to select **RC35 calibration**.
The **SETTINGS\CALIB. RC35** menu is opened.

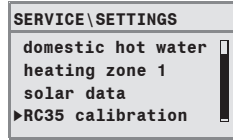

Menu item	Input range	Factory setting	Other information
Calibration of the room temperature	-9.0 °F – +9.0 °F (-5.0 °C – +5.0 °C)	0.0 °F (0.0 °C)	

Tab. 16 Navigator for Service menu *SETTINGS\CALIB. RC35*

Calibration of the displayed room temperature

If there is a separate thermometer near the controls, it may show a different room temperature to that shown on the RC35. This function can be used to adjust the RC35 to match the thermometer (i.e. “calibrate”).

Before calibrating the room temperature, consider the following:

- Is the thermometer more accurate than the RC35?
- Is the thermometer located close to the unit so that they are both subject to the same heat influences (e.g. sunlight, fireplace)?





Other thermometers may show temperature changes more slowly or more quickly than the RC35.

- ▶ Never calibrate the controls when your heating system is in the process of cooling down or heating up, but only in steady state conditions.

Example: if the thermometer is showing a temperature 2 °F (1 °C) higher than the controls, enter “+2 °F (+1 °C)” as the calibration value.

6.7 Contact data

The details entered in "Contact data" are automatically displayed to the customer in the event of a fault. Use this feature to alert the homeowner to call your 24 hour service hotline.

- ▶ Turn the dial  counter-clockwise until **contact data** is selected (marked with ▶).
- ▶ Press  to select **contact data**.
The menu **SETTING\CONTACT** is opened.

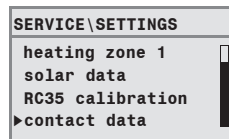





Menu item	Input range	Other information
Name and phone # of heating contractor:	----- -----	

Tab. 17 Navigator for Service menu SETTING\CONTACT

Entering company name and telephone number





Two rows are available, each with 21 characters (capital letters, numbers and some other symbols).

The current cursor position will flash (marked by ▶).

1. Hold down the button  and turn the dial  simultaneously to select another character.
Release the button: the modified character is saved.
2. Turn the dial  counter-clockwise or clockwise to move the cursor.
3. To delete a character, enter a space.
4. Press  to save your entries and leave the menu.

7 Diagnosis

The **Diagnosis** service menu contains a number of diagnostic tools:

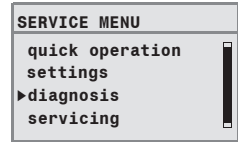

- Function test
 - Monitor value
 - Error message
 - Characteristic heating curve
 - Version information
- ▶ Simultaneously press the  +  +  buttons to open the **SERVICE MENU**.
- ▶ Turn the dial  counter-clockwise to select **Diagnosis** (indicated by ▶).
- ▶ Press  to open the **SERVICE\DIAGNOSIS** menu.



Note that the menu items shown will vary depending on the heating system.

7.1 Function test

Use this menu to activate separate EMS components individually in order to test their functions. The available functions and the possible settings vary depending on the system installed.

- ▶ Hold down the  button and turn the dial at the same time to change the setting: e.g. **BURNER OFF** to **BURNER ON**.
The change takes effect when you release the  button.
- ▶ Turn the dial  to switch between different displays (for function tests).

FUNCT. TEST\BOILER	
valve 1 clsed	2 clsed
ignition	OFF
flame	OFF
flame current	0.0µA
▶BURNER	ON

FUNCT. TEST\BOILER	
act. boilertmp.	140°F
air temperature	90°F
flue gas temp.	172°F
flame	OFF
▶BURNER	OFF



Be mindful of the information which appears on the display when you switch to menus or when you enter settings. Press any of the buttons or turn the dial to confirm the information.



No settings are available that might result in damage to the components. This is why some settings may not be accepted.

7.2 Monitor value

Use the **monitor value** menu to view the target and actual values for the heating system. The target value will be displayed first and then the actual value. The values displayed for monitoring purposes vary depending on the system installed.







If the values to be displayed do not all fit on the screen, they are displayed as a list. Scroll down the list by turning the dial.

DIAGNOSIS\MONITOR	Other information
boiler/burner	
MCMC10/cascade	Only in conjunction with a MCM10 burner (in position "boiler/burner")
boiler ¹⁾	Only in conjunction with a MCM10 burner (in position "boiler/burner")
low loss header	
domestic hot water	
heating zone 1	Values for other heating zones are displayed if such zones are installed.
solar	
bus users	

Tab. 18 Navigator for the monitor value menu

- 1) The monitor values are displayed per boiler on an individual screen. By turning the dial, the monitor values for the next boiler are called up.
Symbol present = corresponding function is active. Key to symbols → Tab. 19, page 44.

	Burner on
	Heat demand
	DHW demand
	Flue gas test
	service due / error

Tab. 19 Key to symbols for footnote 1), page 43

7.3 Error message

The most recent fault from the fault memory can be displayed using the **error message** (e.g. to investigate a fault).

The faults are divided into the following categories:

- Current faults are all unresolved faults currently present in the system. These can be one of the following types: locking, blocking or system error.
- Locking faults: When the fault is remedied, the heating system needs to be unlocked manually. To do so, press the Reset button on the boiler.
- Blocking type faults: With blocking faults, the heating system resumes operation automatically as soon as the fault has been rectified.
- System faults in the heating system are logged in the RC35, with the exception of faults in the boiler or the burner, which are either “locking” faults or “blocking” faults errors. The heating system continues to run – where possible – during the fault state; no reset is necessary.



For a list of the locking and blocking faults, which vary depending on the boiler, see the installation and maintenance instructions of the boiler.

- ▶ Turn the dial to show the next message.

7.4 Characteristic heating curve

Use the **heating curve** menu to view the characteristics of each heating zone in the form of a graph.

- ▶ If the system has more than one heating zone: turn the dial  to view the characteristic heating curve for the next zone.

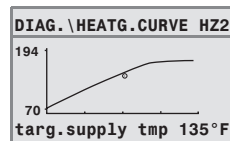

7.5 Versions

You can use the **INFO\VERSIONS** menu to view the software versions for heating system components.

- ▶ If the information cannot be displayed in one screen: turn the dial to display the next screen.

INFO \ VERSIONS	
RC35	1.02
UBA3.5	1.21

8 Service

The **servicing** menu is used to set a service interval and to view and reset current service messages.

The interval can be set to expire either after a given number of operating hours or when a given date is reached. The RC35 will then show a message so that the customer can notify the heating contractor to arrange an appointment.

Service messages are indicated by an **Hxx** code, e.g. H07.

SERVICE MENU\ SERVICE	Menu item	Input range	Factory setting	Other information
service interval	How should servicing messages be triggered?	no messages, by run time, by date	no messages	Selecting “run time” or “date” takes you automatically to the corresponding setting.
	For “by date”: Annual servicing, starting on:	01/01/2009	01/01/2009	To set the date: hold down  and turn the dial at the same time.
	For “by operation hours”: Boiler operation hours until next servicing message	1000 h – 6000 h	6000 h	Number of hours of operation with burner switched on
current messages	Message/code			To view further messages: turn the dial.
RESET service	Confirm resetting the service messages.	no, yes	no	If you select “yes” the servicing messages will be reset. Observe information in display.

Tab. 20 Navigator for the Servicing menu



9 Reset

The **SERVICE MENU\RESET** resets the following:

- All parameters back to their factory settings
- Fault list
- Service messages
- The run time.



After resetting parameters to the factory setting, the parameters may need to be adjusted again to suit the system configuration.

- ▶ Turn the dial to select a menu, e.g. **fault list**. Press  to go to the relevant screen, e.g. **Confirm resetting the list of faults**. Press  and turn the dial to set the display to **yes**.
When the button is released, the reset is carried out.
During this process, a corresponding message appears, which disappears again automatically.
- ▶ Once reset is complete: confirm by pressing any of the buttons.

10 Troubleshooting

This fault table lists possible “system errors”, i.e. faults of heating system components. The heating system keeps operating as much as possible in the event of a system error; in other words, heating of the home can continue as long as it is safe.



Use only original Buderus parts. Losses caused by the use of parts not supplied by Buderus are excluded from the Buderus warranty.



The faults displayed will vary depending on the specific type of boiler in use.

Abbreviations used:

SC = Service code; x = heating zone with the number x, e.g. A23 for heating zone 3

FC = Fault code

HZx = Heating zone with the number x

SC	FC	Fault message	Effect on control characteristics	Possible cause	Remedy
A01	800	Outdoor sensor defective.	The minimum outdoor temperature is used instead of the actual outdoor temperature.	Sensor incorrectly connected or installed. Break or short circuit in the sensor lead. Temperature sensor is defective.	<ul style="list-style-type: none"> ▶ Check the sensor connection and the sensor lead. ▶ Check that the sensor is correctly mounted. ▶ Compare resistance values with the characteristic sensor curve.

Tab. 21 Fault table

SC	FC	Fault message	Effect on control characteristics	Possible cause	Remedy
A01	808	DHW sensor 1 defective.	Heating of domestic hot water is stopped.	Sensor incorrectly connected or installed. Breakage or short circuit in the sensor lead. Temperature sensor is defective.	<ul style="list-style-type: none"> ▶ Check the sensor connection and the sensor lead. ▶ Check that the sensor is correctly mounted. ▶ Compare resistance values with the characteristic sensor curve.
A01	809	DHW sensor 2 defective.			
A01	810	DHW stays cold.	The system continuously attempts to heat the DHW tank to the set target temperature for DHW. DHW priority is switched off once this fault message appears.	Constant drawing or system leak.	▶ Fix any leaks
				Sensor incorrectly connected or installed. Breakage or short circuit in the sensor lead. Temperature sensor is defective.	<ul style="list-style-type: none"> ▶ Check the sensor connection and the sensor lead. ▶ Check that the sensor is correctly mounted. ▶ Compare resistance values with the characteristic sensor curve.
				DHW pump incorrectly connected or defective.	▶ Check that the DHW pump is working, e.g. by carrying out a function test.

Tab. 21 Fault table

SC	FC	Fault message	Effect on control characteristics	Possible cause	Remedy
A01	811	Thermal disinfection was unsuccessful.	Thermal disinfection has been interrupted.	Water draw too great during the disinfection period.	▶ Select a time for thermal disinfection when there is no other demand heat.
				Boiler output is too low for heat to be used for other purposes at the same time (e.g. 2nd heating zone).	
				Sensor incorrectly connected or installed. Breakage or short circuit in the sensor lead. Temperature sensor is defective.	▶ Check the sensor connection and the sensor lead. ▶ Check that the sensor is correctly mounted. ▶ Compare resistance values with the characteristic sensor curve.
				DHW pump is faulty.	▶ Check that the DHW pump is working, e.g. by carrying out a function test.
A01	816	No communication with UBA3/MC10/MCM10	The boiler no longer receives heat demand signals; the heating system no longer provides heat.	EMS bus system is overloaded.	▶ Reset by switching the heating system on and off. ▶ Notify customer support if needed.
				UBA3/MC10/MCM10 is defective.	
A01	828	Water pressure sensor defective.		Digital water pressure sensor is defective.	▶ Replace the water pressure sensor.
A02	816	No communication with BC10	BC10 settings are no longer accepted by RCxx devices.	Contact problem on BC10, or BC10 faulty.	▶ Check BC10 connection. ▶ Replace BC10 if necessary.

Tab. 21 Fault table

SC	FC	Fault message	Effect on control characteristics	Possible cause	Remedy
A11	801	internal error	Heating system is in emergency mode.	Internal runtime error in the RC35.	► Replace RC35.
A11	802	Time not set.	Restricted functionality for: <ul style="list-style-type: none"> • All programs • Fault messages 	Time details are missing, e.g. due to lengthy power failure.	► Enter the current time.
A11	803	Date not set.	Restricted functionality for: <ul style="list-style-type: none"> • All programs • Vacation function • Fault messages 	Date details are missing, e.g. due to lengthy power failure.	► Enter the current date.
A11	804	internal error	Heating system is in emergency mode.	Internal runtime error in the RC35.	► Replace RC35.
A11	806	Room temperature sensor defective.	Since the actual room temperature is missing, the following functions do not work: <ul style="list-style-type: none"> • Room influence (for outdoor temperature control) • Switch point optimization In the case of room temperature control, the system is regulated to max. temperature for HZx.	Built-in temperature sensor on the RC35 controls/remote control unit is defective.	► Replace the remote control unit.
A12	815	Sensor separator module is defective.	Effects include inadequate supply to downstream heating zones as they can no longer be supplied with the requested heat amount.	Sensor incorrectly connected or installed. Breakage or short circuit in the sensor lead. Temperature sensor is defective.	► Check the sensor connection and the sensor lead. ► Check that the sensor is correctly mounted. ► Compare resistance values with the characteristic sensor curve.

Tab. 21 Fault table

SC	FC	Fault message	Effect on control characteristics	Possible cause	Remedy
A12	816	No communication with LL header module.	Heating zone pump 1 is permanently activated.	WM10 or bus cable is incorrectly connected or faulty. WM10 not recognized by RC35.	<ul style="list-style-type: none"> ▶ Check terminals on WM10 and check bus cable. ▶ Replace WM10.
A2x	806	Room temperature for HZx defective.	<p>Since the actual room temperature is missing, the following functions do not work:</p> <ul style="list-style-type: none"> • Room influence (for outdoor temperature control) • Switch point optimization <p>In the case of room temperature control, the system is regulated to max. temperature for HZx.</p>	Built-in temperature sensor on the RC35 controls/remote control unit is defective.	<ul style="list-style-type: none"> ▶ Replace the remote control unit.
A2x	842	Frost protection w/o remote HZx.	<p>Since the actual room temperature is missing, the following functions do not work:</p> <ul style="list-style-type: none"> • Room influence • Switch point optimization 	No user interface/remote control unit assigned, although frost protection is set to room temperature.	<ul style="list-style-type: none"> ▶ Check the operating unit parameter. ▶ Change frost protection to outdoor temperature if needed.
A2x	843	Room control w/o remote HZx.	EMS operates with the last values set on the remote control.	No RC35 user interface/remote control unit assigned, although room temperature controlled is set.	<ul style="list-style-type: none"> ▶ Check the operating unit parameter. ▶ Change to outdoor temperature controlled if needed.

Tab. 21 Fault table

SC	FC	Fault message	Effect on control characteristics	Possible cause	Remedy
A3x	807	HZx supply sensor defective.	Break or short circuit in the sensor lead. Heating zone pump continues to be activated in accordance with the default value. The valve is isolated electrically and remains in the last position set by the controller (it can be adjusted by hand).	Sensor incorrectly connected or installed. Break or short circuit in the sensor lead. Sensor is faulty.	<ul style="list-style-type: none"> ▶ Check the sensor connection and the sensor lead. ▶ Check that the sensor is correctly mounted. ▶ Compare resistance values with the characteristic sensor curve.
A3x	816	No communication with HZx mixer module.	Heating zone x cannot be operated correctly. MM10 and valve (the mixer) run automatically in emergency mode. Heating zone pump is permanently activated. Monitoring data in RC35 is invalid.	The heating zone addresses on the MM10 and RC35 do not match. MM10 or bus cable is incorrectly connected or faulty. MM10 not recognized by RC35.	<ul style="list-style-type: none"> ▶ Check the dial on the MM10. ▶ Check terminals on MM10 and check bus cable. ▶ Replace MM10.
Hxx		Service message; no system fault.	The heating system keeps operating as much as possible.	Example: service interval expired.	Maintenance is required; see boiler documentation.

Tab. 21 Fault table



System errors do not need resetting. Contact your local service contractor or your local Buderus office if you cannot remedy the fault yourself. Other faults are described in the technical documentation for the boiler.

11 Service menu RC35

RC35 Service menu

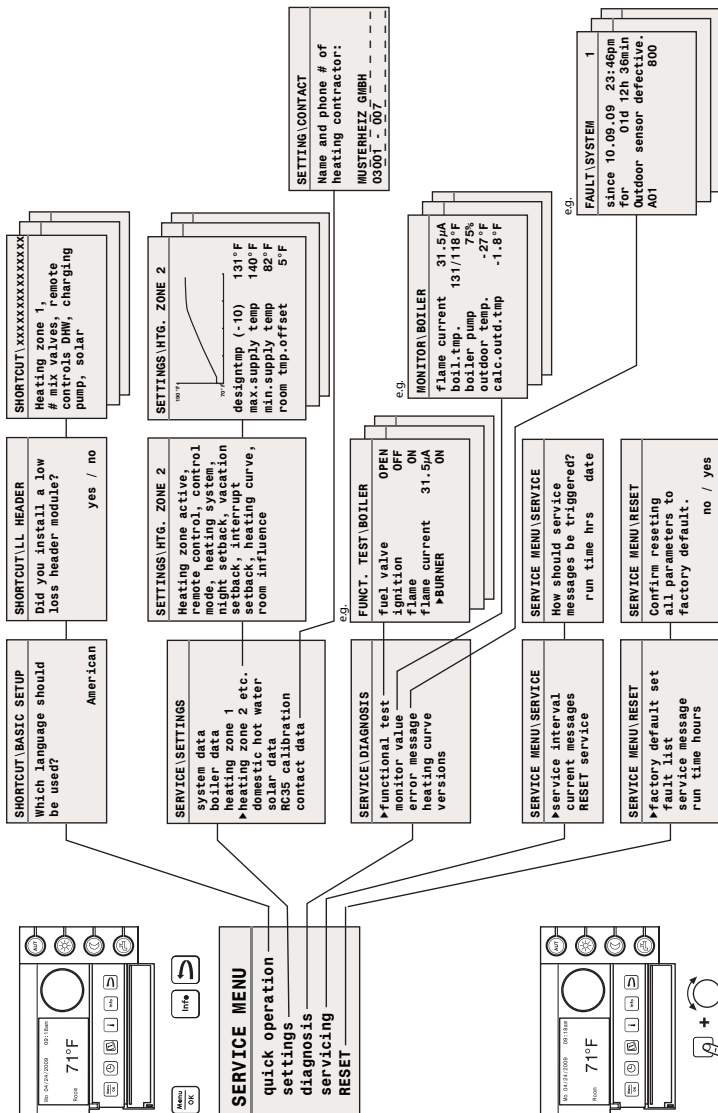

6 720 640 224-07.1RS

Index

- A**
- Accessories 9
 - Actual values, viewing 43
- B**
- Boiler data, Service menu – Settings 27
 - Building type 25
 - Burner control unit 7, 47
- C**
- Calibration, room temperature display 40
 - Char. curve, Service menu – Diagnosis ... 45
 - Checklist, parameters for
 - commissioning 19
 - Commissioning 18
 - Commissioning, quick 20
 - Connection 12
 - Contact data, entering 41
 - Contrast on display 18
 - Control mode 32
 - Controls, overview of 14
 - Correct use 7
- D**
- Damping of outdoor temperature 25
 - Design day temperature 33
 - DHW
 - Service menu – Settings 37
 - target temperature 37
 - temperature limit 37
 - DHW circulation 37–38
 - DHW priority 28–31
 - Diagnosis, Service menu 42
 - Disinfection, thermal 37–38
- E**
- EMS 7, 23
 - EMS bus, devices on 23
 - Errors, Service menu – Diagnosis 44
- F**
- Fault memory, viewing 44
 - Freezing 6
 - Frost protection 35
 - Function test, Service menu – Diagnosis . 42
- H**
- Heat storage capacity 25
 - Heating characteristic curve
 - viewing 45
 - Heating characteristics
 - instructions for setting 33
 - Heating zone
 - installing 24
 - Service menu – Settings 28
 - Hydraulic separator, installing 24
- I**
- Installation 12
- L**
- Language, setting 24
 - Low loss header module WM10 9
- M**
- Minimum clearances 10
 - Minimum outdoor temperature 26
 - Mixer 28–31
 - Mixing module MM10 9
 - Modulation, boiler pump 27
 - Monitor value, Service menu – Diagnosis . 43
- N**
- Night setback 34
- O**
- Outdoor setback mode 34
 - Outdoor temperature control 32
 - Outdoor temperature, “damped” 25

P	
Power failure	22
Program, optimizing	28–31
Pump after-run time	27
Pump anti-seize	23
Pump logic temperature	27
Q	
Quick operation, Service menu	20
R	
Reduced operation	34
Reduction mode (night setback)	34
Reference room	10
Remedy fault	48
Reset, Service menu	47
Room influence	32
Room setback mode	34
Room temperature offset	33
S	
Safety instructions	6
Scope of delivery	7
Screed, drying	28–31
Service interval, setting	46
Service menu, introduction	15
Service menu, overview of the menus	17
Service messages, viewing/resetting	46
Servicing, Service menu	46
Setback, interrupting (frost protection)	35
Shut-down mode	34
Shutting down	22
Single charge LED, switching off	37–38
Solar data, Service menu – Settings	39
Solar module, installing	24
Supply temperature	33
Switching off	22
System data, Service menu – Settings	24
T	
Target values, viewing	43
Technical specifications	8
Testing components	42
Thermal disinfection	37–38
Thermostatic valves in reference room	23
U	
User interface	
- assignment in software	32
- attaching or removing	13
- for heating zone	28
V	
Versions, Service menu – Diagnosis	45
Versions, viewing	45
W	
Weather-dependent control	32



Notes



Notes



Notes

United States and Canada

Bosch Thermotechnology Corp.
50 Wentworth Avenue
Londonderry, NH 03053
Tel. 603-552-1100
Fax 603-584-1681
www.buderus.net
U.S.A.

Products manufactured by
Bosch Thermotechnik GmbH
Sophienstrasse 30-32
D-35576 Wetzlar
www.buderus.de

Bosch Thermotechnology Corp. reserves the right
to make changes without notice due to continuing
engineering and technological advances.

Buderus